



Spezifikationen

Modell	Einheit	ACV-05		ACV-10			ACV-15			ACV-20			ACV-25		ACV-30			
		HS	LS	HS	LS	HR	HS	LS	HR	HS	LS	HR	HS	LS	HS	LS		
Medium		Ölfreie Druckluft																
Umgebungstemperatur	°C	0-60(frostfrei)																
Speisedruckbereich	bar	1-6																
Düsendurchmesser	Ømm	0,5		1,0			1,5			2,0			2,5		3,0			
Speisedruck	bar	5		5			3,5			5			3,5		5			
Saugleistung	l/min	7	10	27	36	25	63	95	54	110	170	88	160	250	225	350		
Max.Unterdruck	kPa	-87	-57	-92	-57	-91	-92	-57	-91	-92	-57	-91	-92	-57	-92	-57		
Luftverbrauch	l/min	13		44			100			180			265		385			
Netto-Gewicht	Ohne Druckschalter	g		80			80			140			350		730		870	
	Mit Druckschalter	g		120			120			190			460			-		-

Bestellung

ACV - 05 H S CK

① ② ③ ④

① Düsendurchmesser ② Max. Unterdruck

① Düsendurchmesser		② Max. Unterdruck	
05	Ø0,5	H	-87 kPa (Endvakuumtyp)
10	Ø1,0	L	-53 kPa (Durchflusstyp)
15	Ø1,5	③ Speisedruck	
20	Ø2,0		
25	Ø2,5		
30	Ø3,0	S	5 bar
		R	3,5 bar

④ Druckschalter

④ Druckschalter	
keine	Standard (ohne Druckschalter)
CK	Mit einstellbarem Druckschalter
C	Mit nicht einstellbarem Druckschalter

Hinweis: Bei Düsendurchmesser 30 ist nur die Standardausführung (ohne Druckschalter) verfügbar

Ersatzteilübersicht

Schalldämpfer

PSU01	ACV-05, ACV-10
PSU02	ACV-15
PSU04	ACV-20
ABS06	ACV-25, ACV-30

• Druckschalter
ACV-CK

• Kombinationstabelle

①	②	③		④
		S	R	
05	H	○	×	○
	L	○	×	○
10	H	○	○	○
	L	○	×	○
15	H	○	○	○
	L	○	×	○
20	H	○	○	○
	L	○	×	○
25	H	○	×	○
	L	○	×	○
30A	H	○	×	×
	L	○	×	×

ABM

ABX

ABM/ABX
Kombityp

AM

AL

AH

AM
Kombityp

AL
Kombityp

AH
Kombityp

AZL112

AZL212

ACP

ACPF

ACV

AZH

AZU

ASBP

Daten Druckschalter

Modell	Einheit	CK	
Medium		Luft	
Einstelldruckbereich	kPa	-20...-53	
Umgebungstemperatur	°C	0-60(frostfrei)	
Arbeitsgenauigkeit	kPa	±5,3	
Hysterese	kPa	4,0...13,3	
Betriebsspannung	V	AC 250 V max.	DC 24 V max.
Laststrom	A	3	0,2

Symbol

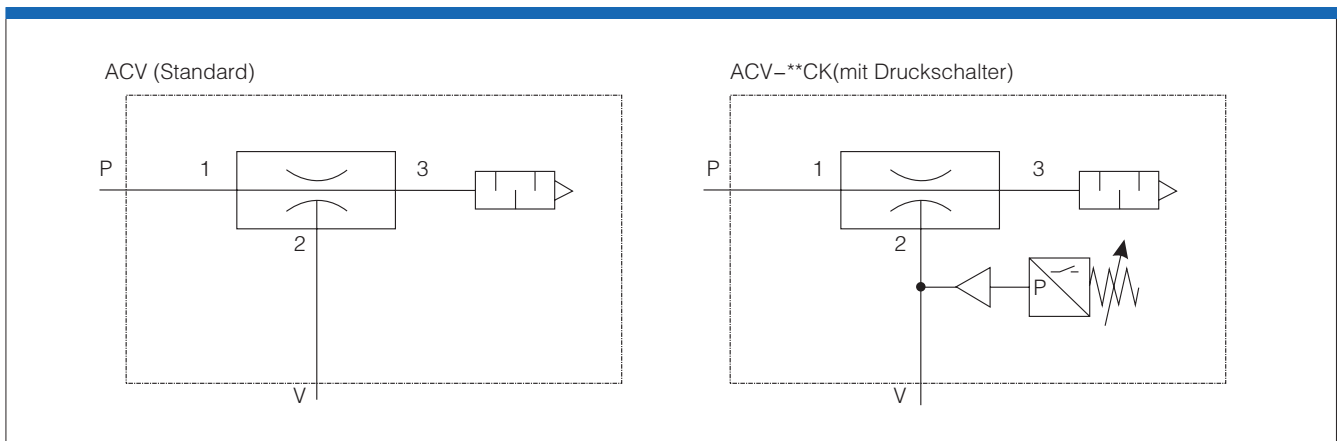

Aufbau

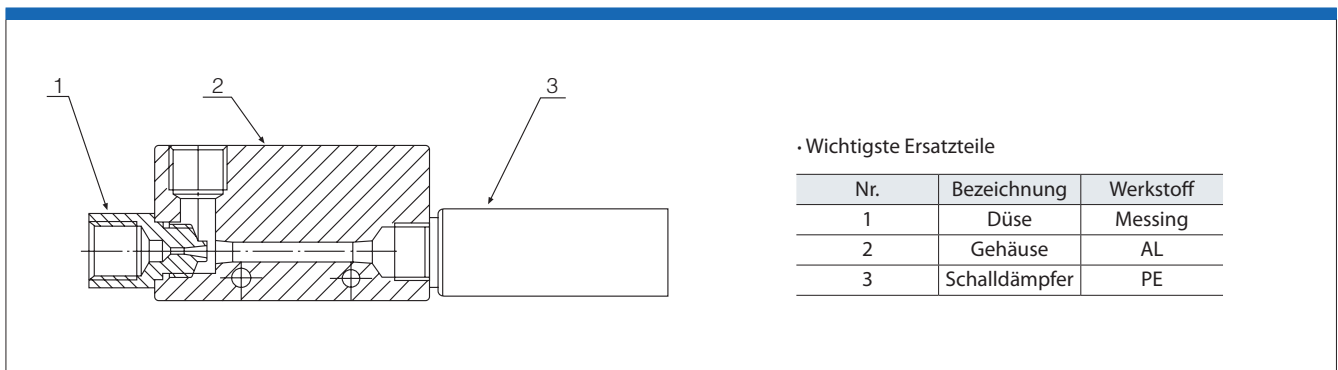

Saugleistung (l/min) bei verschiedenen Unterdrücken (-kPa)

Modell \ -kPa	Speisedruck	Luftverbrauch	0	10	20	30	40	50	60	70	80	Max. Unterdruck
ACV-05HS	5 bar	13 l/min	7	5,5	4,2	3	1,5	0,8	0,5	0,2	0,05	-87 kPa
ACV-10HS		44 l/min	27	19	16	14,5	13	10,5	8	6,5	2,5	-92 kPa
ACV-15HS		100 l/min	63	55	44	37	32,5	25	18	14	9	
ACV-20HS		180 l/min	110	100	85	75	55	40,5	30	20	12	
ACV-25HS		265 l/min	160	155	140	120	95	72	47	28	15	
ACV-30HS		385 l/min	225	200	160	135	105	78	55	33	19	

Evakuierungszeit (s/l) bis zum Erreichen verschiedener Vakuumpiegel (-kPa)

Modell \ -kPa	Speisedruck	Luftverbrauch	10	20	30	40	50	60	70	80	Max. Unterdruck
ACV-05HS	5 bar	13 l/min	0,676	1,384	2,769	4,323	6,015	8,246	9,438	11,820	-87 kPa
ACV-10HS		44 l/min	0,2	0,492	0,815	1,246	1,738	2,323	2,953	4	-92 kPa
ACV-15HS		100 l/min	0,078	0,187	0,32	0,477	0,692	0,924	1,384	1,953	
ACV-20HS		180 l/min	0,043	0,1	0,167	0,23	0,338	0,492	0,707	0,923	
ACV-25HS		265 l/min	0,03	0,069	0,112	0,168	0,241	0,345	0,494	0,753	
ACV-30HS		385 l/min	0,029	0,058	0,092	0,136	0,196	0,265	0,406	0,625	

· ACV-05HS

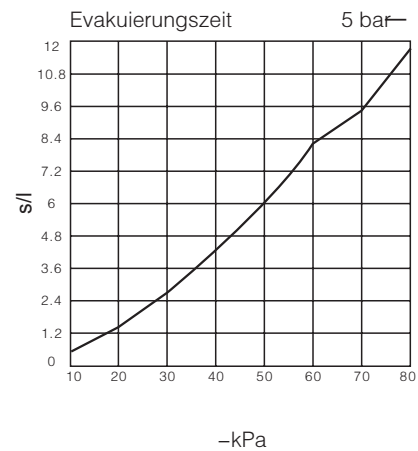
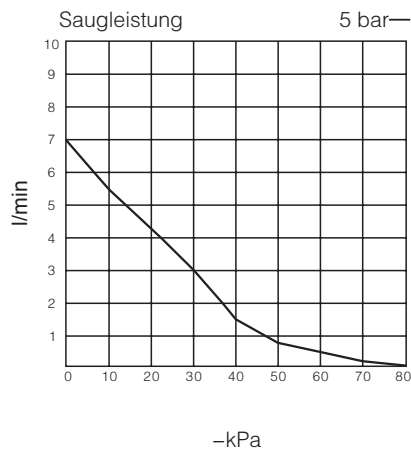

· ACV-10HS

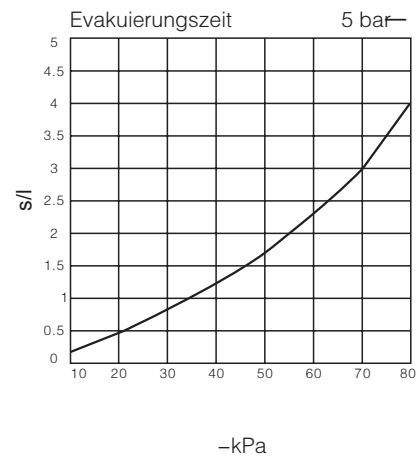
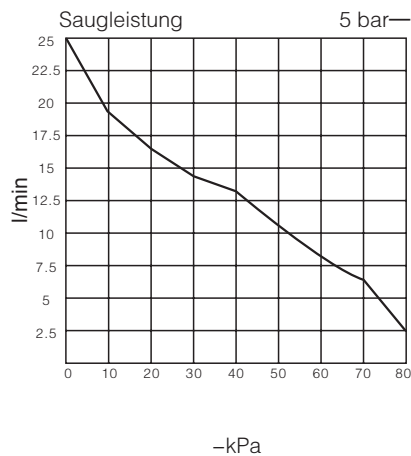

ABM

ABX

ABM/ABX
Kombityp

AM

AL

AH

AM
Kombityp

AL
Kombityp

AH
Kombityp

AZL 112

AZL 212

ACP

ACPF

ACV

AZH

AZU

ASBP

· ACV-15HS

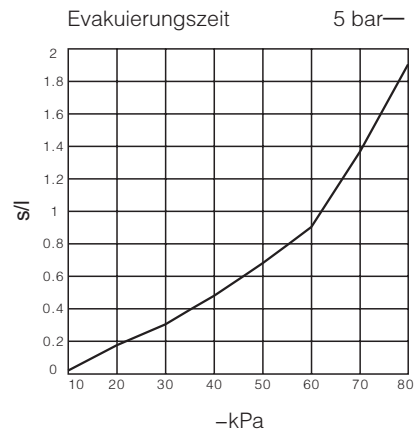
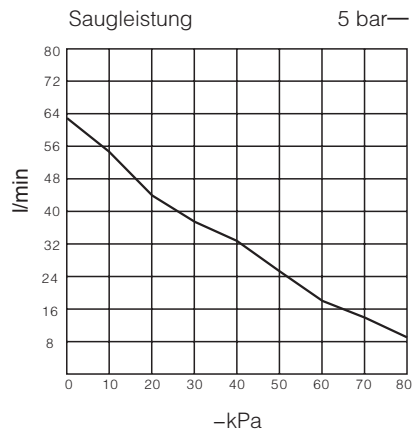

· ACV-20HS

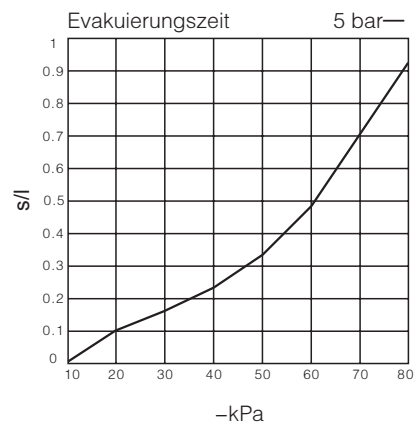
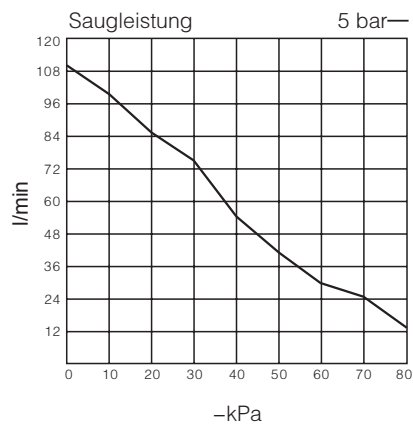

· ACV-25HS

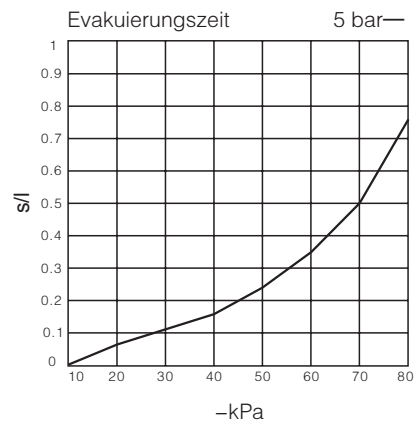
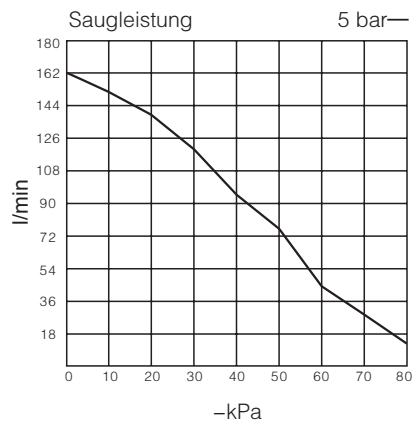

· ACV-30HS

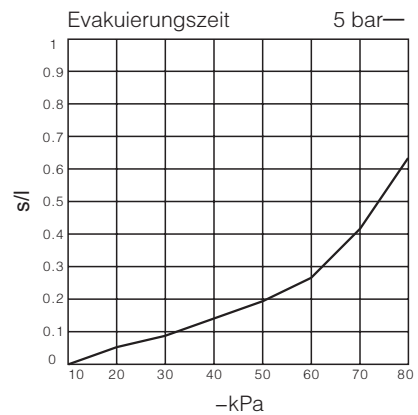
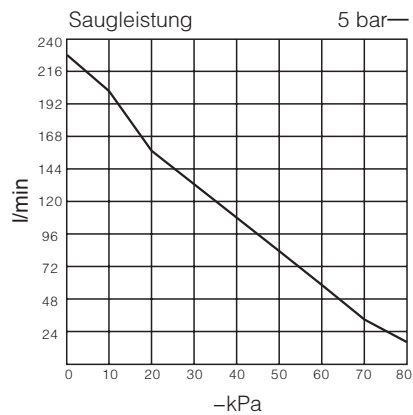

Saugleistung (l/min) bei verschiedenen Unterdrücken (-kPa)

Modell	-kPa	Speisedruck	Luftverbrauch	0	10	20	30	40	50	55	Max. Unterdruck
ACV-05LS	5 bar	5 bar	13 l/min	10	9	8	6,5	2,5	1,8	0,7	-57 kPa
ACV-10LS			44 l/min	36	31,5	23,5	16,5	10	6,5	2,5	
ACV-15LS			100 l/min	95	85	70	47,5	30,5	15,5	5,5	
ACV-20LS			180 l/min	170	125	115	95	70	35,5	7,5	
ACV-25LS			265 l/min	250	215	200	150	105	60	36	
ACV-30LS			385 l/min	350	295	267	215	150	85	41	

Evakuierungszeit (s/l) bis zum Erreichen verschiedener Vakuumpegel (-kPa)

Modell	-kPa	Speisedruck	Luftverbrauch	10	20	30	40	50	55	Max. Unterdruck
ACV-05LS	5 bar	5 bar	13 l/min	0,307	0,984	1,892	3,169	5,123	6,66	-57 kPa
ACV-10LS			44 l/min	0,107	0,277	0,507	0,830	1,323	1,414	
ACV-15LS			100 l/min	0,044	0,102	0,153	0,261	0,415	0,553	
ACV-20LS			180 l/min	0,029	0,062	0,105	0,138	0,246	0,338	
ACV-25LS			265 l/min	0,021	0,046	0,076	0,123	0,184	0,3	
ACV-30LS			385 l/min	0,017	0,035	0,058	0,086	0,132	0,219	

· ACV-05LS

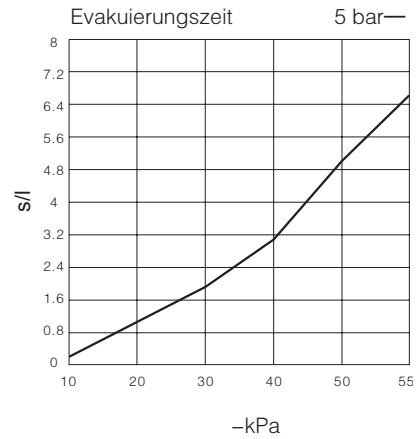
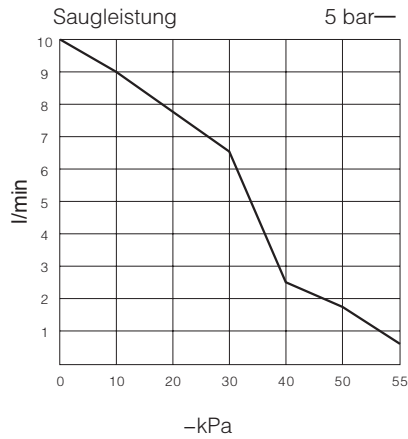

· ACV-10LS

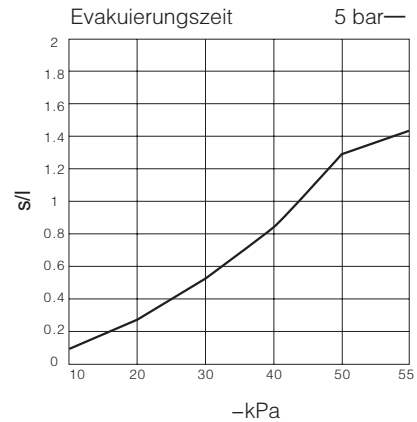
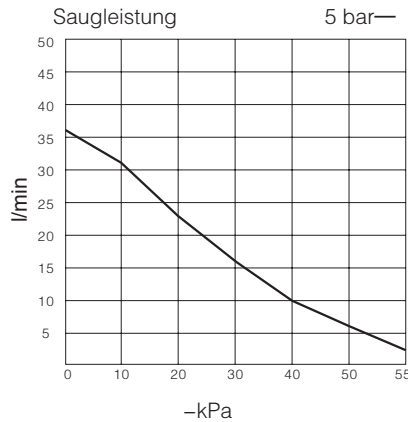

- Vakuumerzeuger
- ABM
- ABX
- ABM/ABX Kombityp
- AM
- AL
- AH
- AM Kombityp
- AL Kombityp
- AH Kombityp
- AZL 112
- AZL 212
- ACP
- ACPF
- ACV
- AZH
- AZU
- ASBP

· ACV-15LS

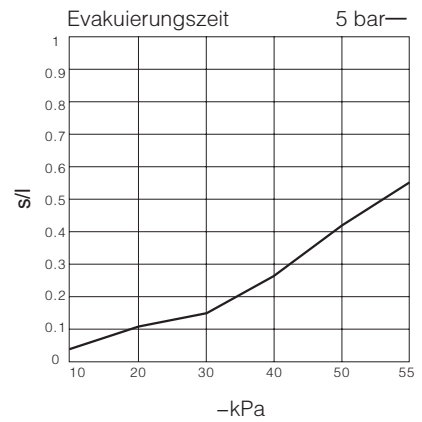
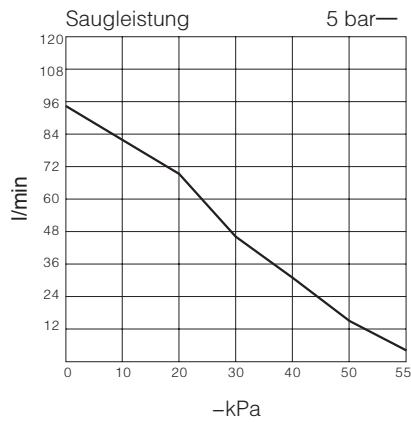

· ACV-20LS

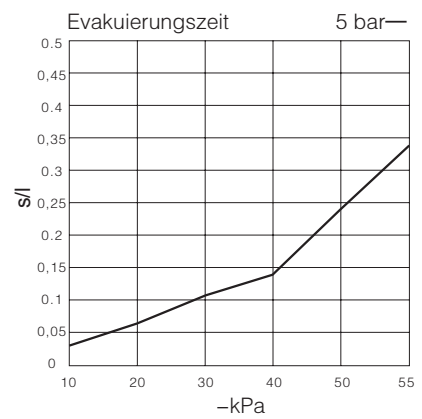
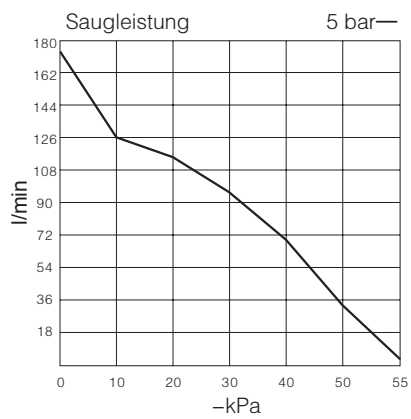

· ACV-25LS

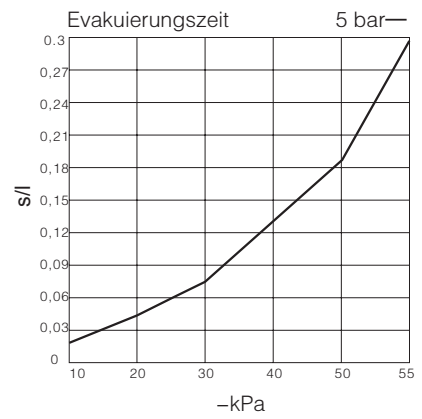
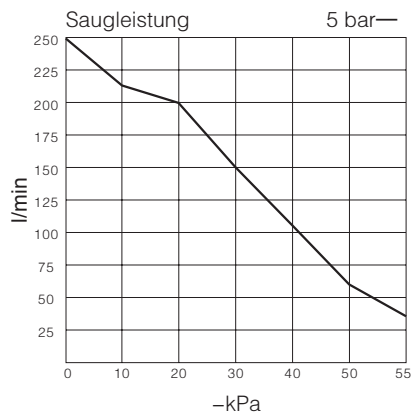

· ACV-30LS

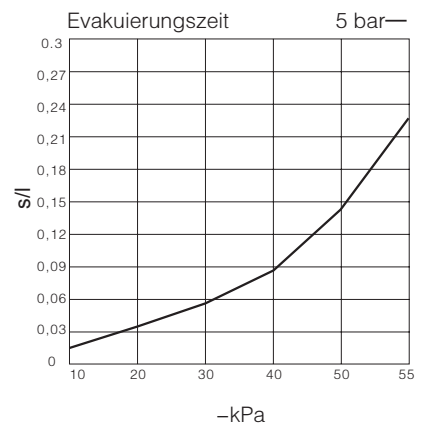
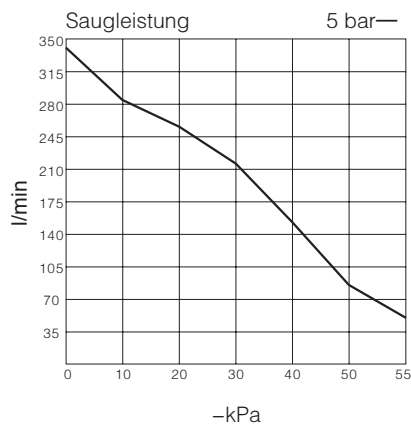

Abmessungen (mm)

- ACV-□□Standard (ohne Druckschalter)

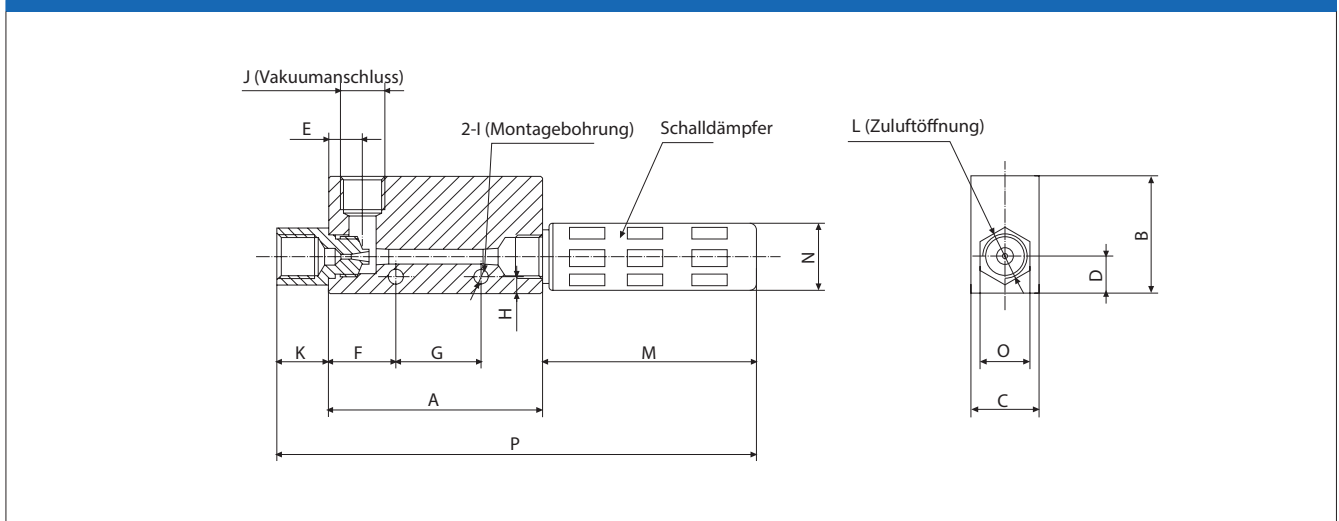

Modell	A	B	C	D	E	F	G	H	I	J	K	L	M	N	O	P	Montageschraube Schalldämpfer
ACV05	45	33	16	10	8	14	20	4,5	2-φ4,5	Rp1/8	10	Rp1/8	34	Φ16	14	89	Rp1/8
ACV10	45	33	16	10	8	14	20	4,5	2-φ4,5	Rp1/8	10	Rp1/8	34	Φ16	14	89	Rp1/8
ACV15	63	35	20	11	10	20	25	5	2-φ4,5	Rp1/4	15	Rp1/4	54	Φ21	17	132	Rp1/4
ACV20	85	40	30	15	13	28	32	7	2-Φ6	Rp3/8	20	Rp1/4	80	Φ30	24	185	Rp1/2
ACV20CK	85	50	30	15	13	28	32	7	2-Φ6	Rp3/8	20	Rp1/4	80	Φ30	24	185	Rp1/2
ACV25	100	60	40	20	16	20	50	5,5	2-Φ6	Rc1/2	17	Rc3/8	90	Φ37	28	207	Rp3/4
ACV30	118	60	40	20	20	33	50	5,5	2-Φ6	Rc3/4	20	Rc1/2	90	Φ37	30	228	Rp3/4

- ACV-CK (mit einstellbarem Druckschalter)

